

ITEM	QTY	DESCRIPTION	LENGTH
1	2	PFC 150x90	6050
2	1	PFC 150x90	2258
3	1	PFC 150x90	2424
4	1	RHS 150x100x5.0	5850
5	2	RHS 150x100x5.0	2432
6	1	SHS 100x100x5.0	5850
7	4	SHS 50x50x5.0	400
8	4	Upright A	2100
9	2	Upright B	2100
10	4	Upright C	2100
11	2	Upright D	2100
12	2	RSA 50x50x5.0	2158
13	8	Recess Crossmember 50x50	850
14	4	Door Crossmember 90x50	2000
15	2	Tread Plate Alu - check	1990
16	2	Joining Plate A FLAT 80x5.0	126
17	2	Joining Plate B	126
18	4	FLAT 80x15.0	150
19	4	RoofBar A c profile	2238
20	5	RoofBar B z profile	2238
21	1	RoofBar C c profile	1600
22	1	RoofBar D c profile	1600
23	2	Angle 25x25x2.0	1600
24	1	Emergency Stop Pocket	160

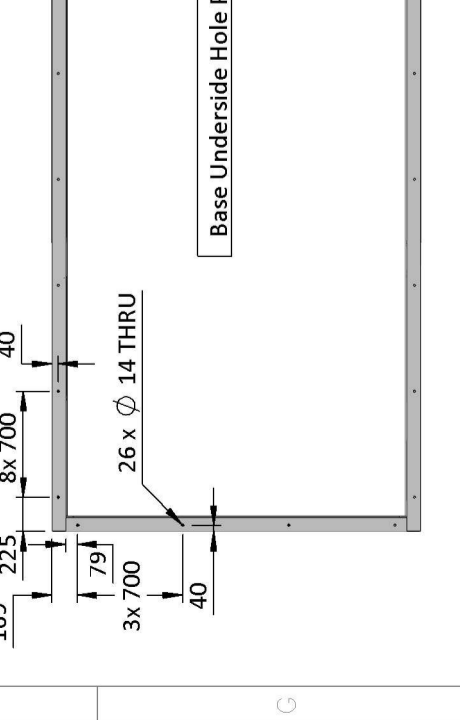
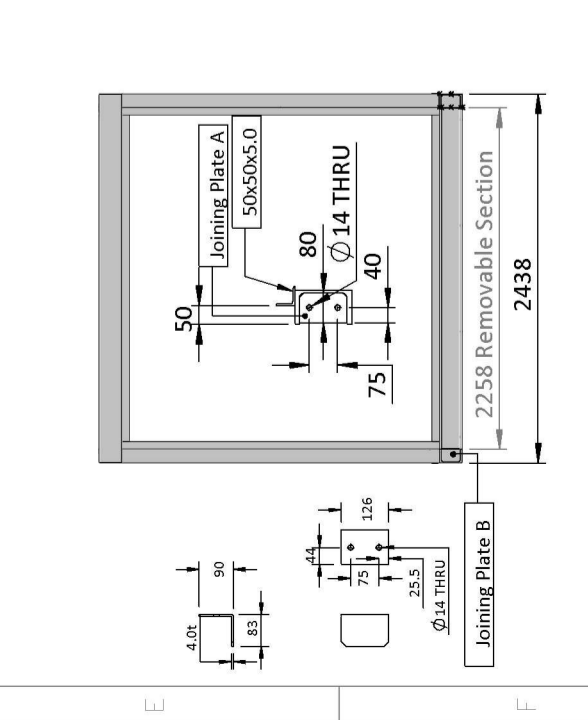
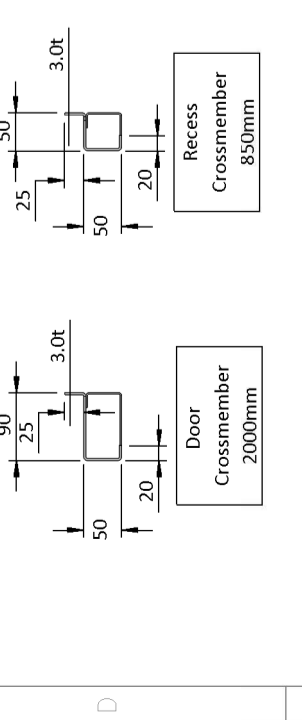
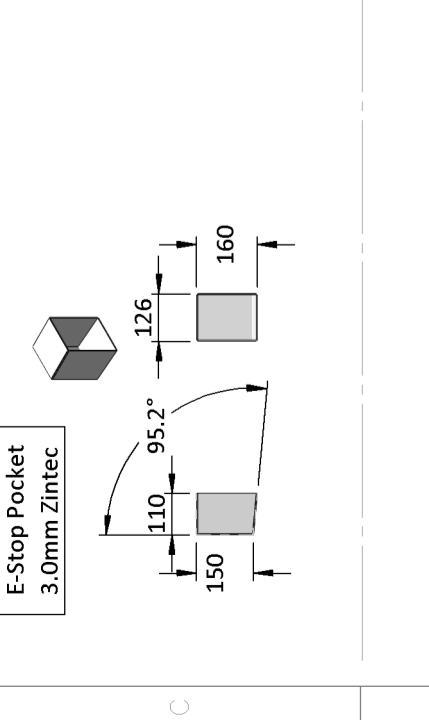
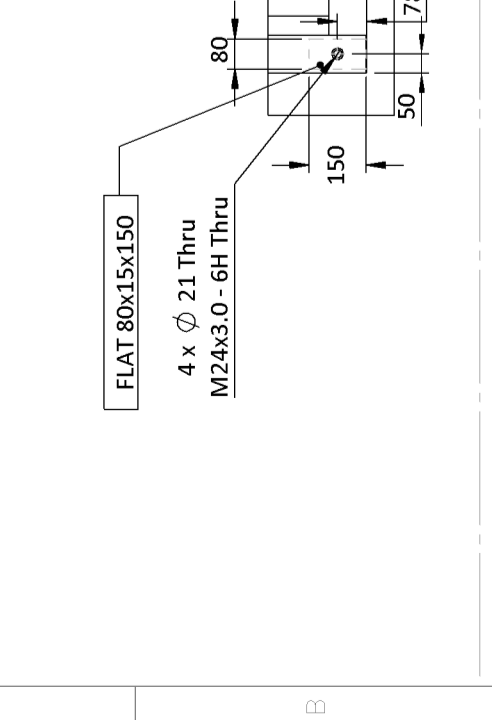
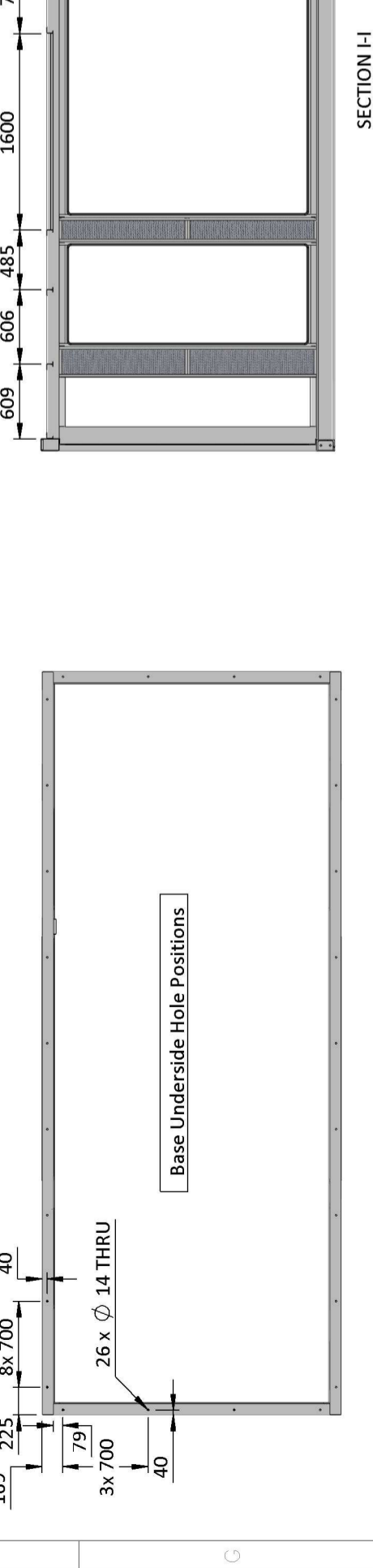
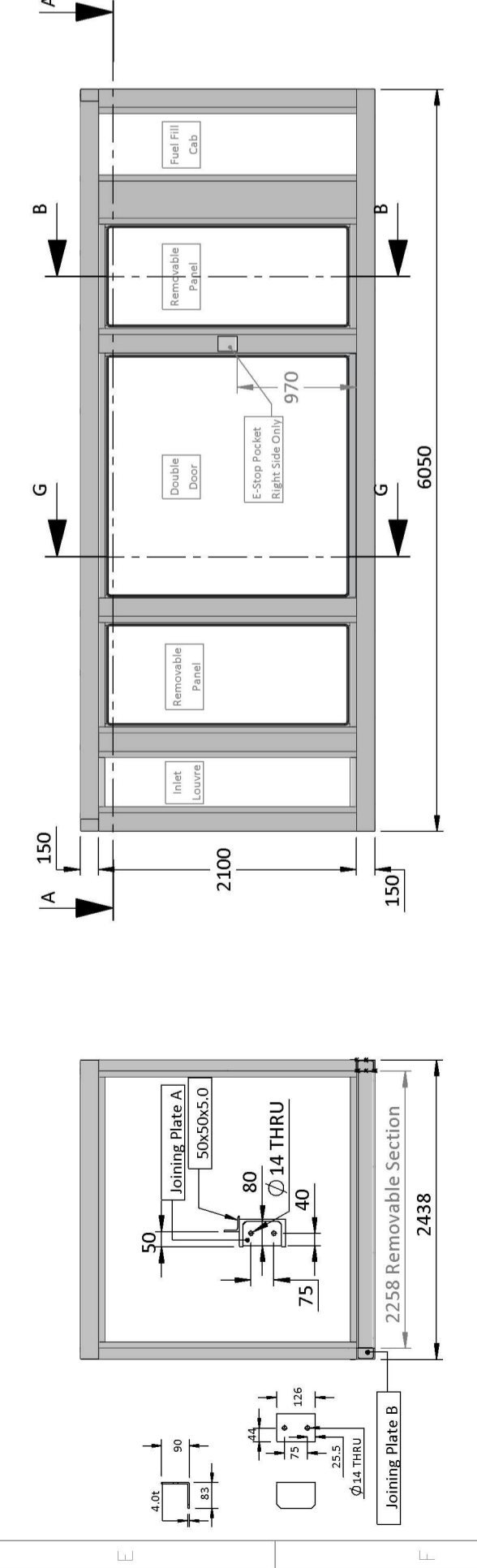
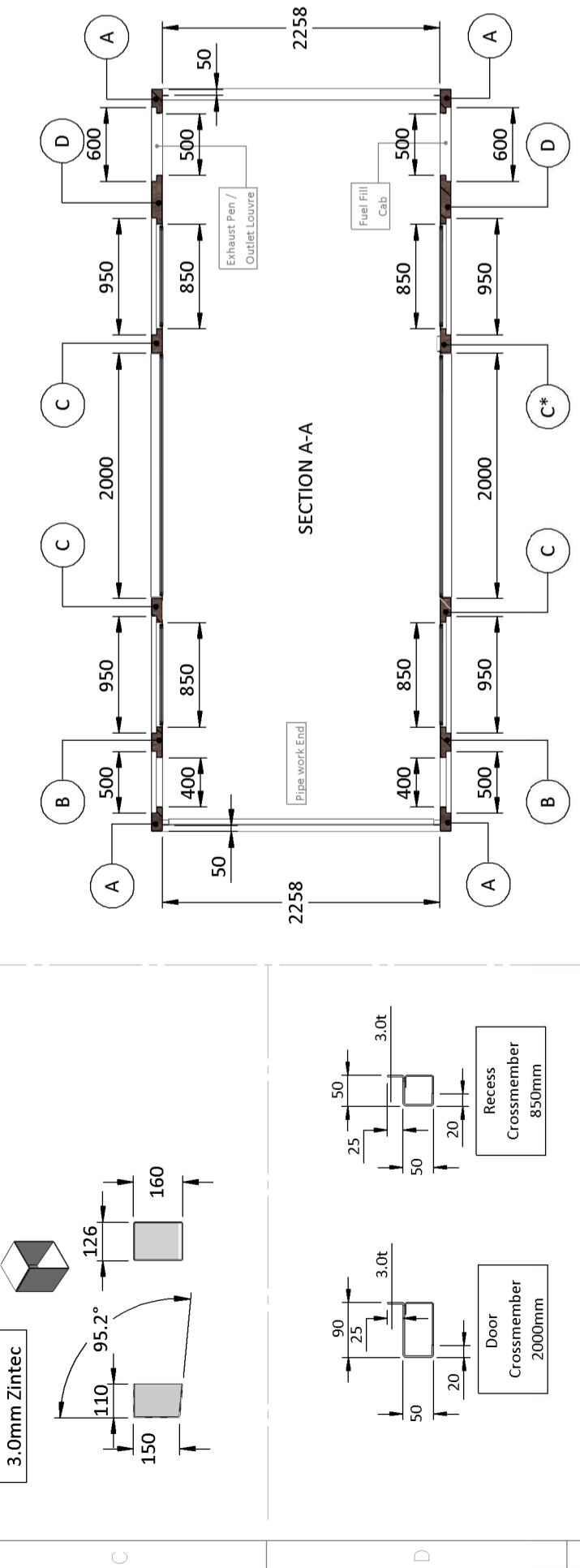
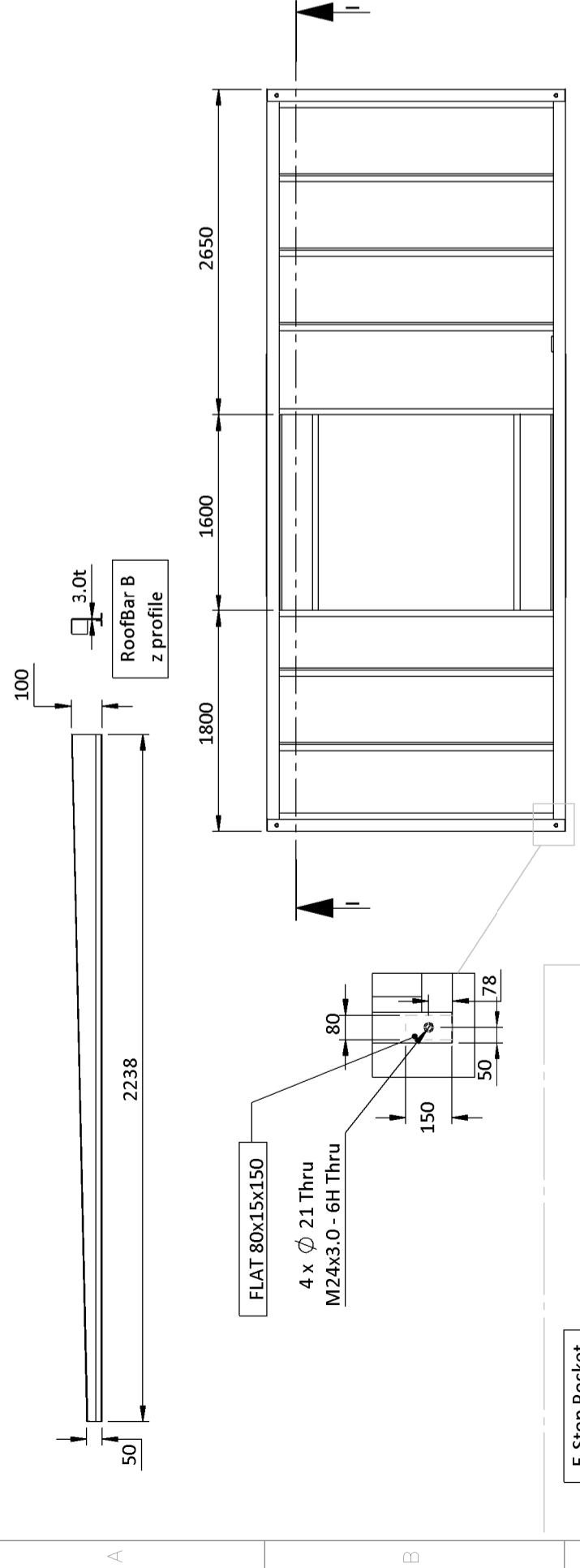
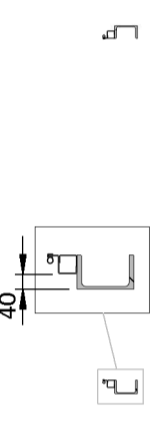
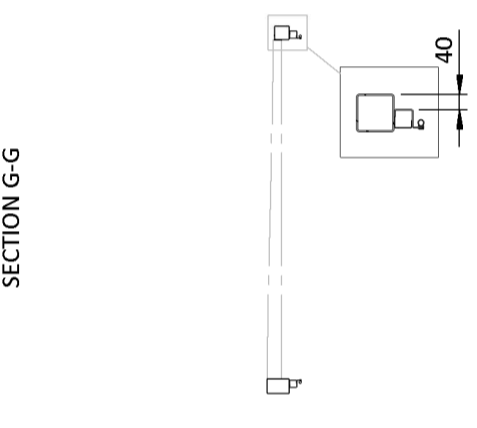
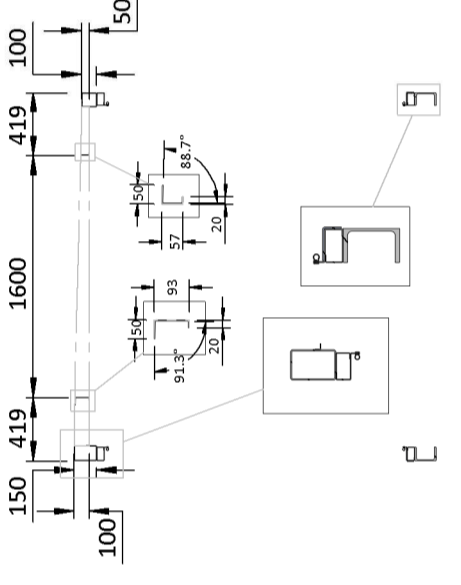
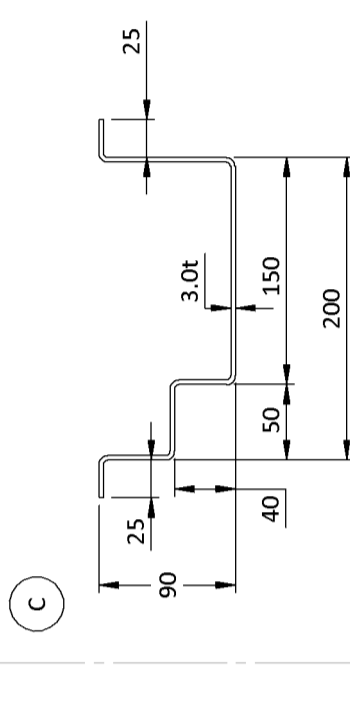
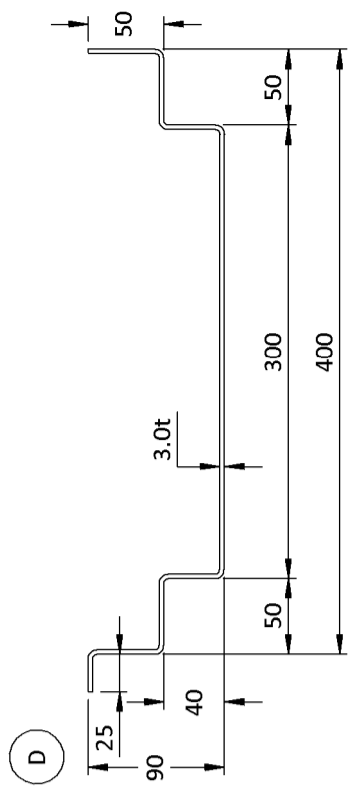
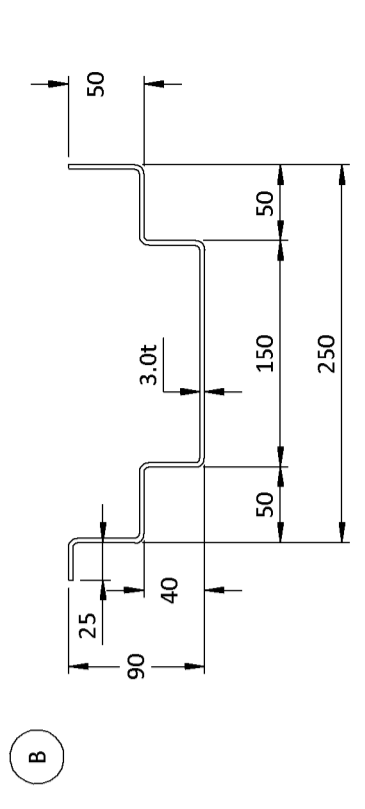
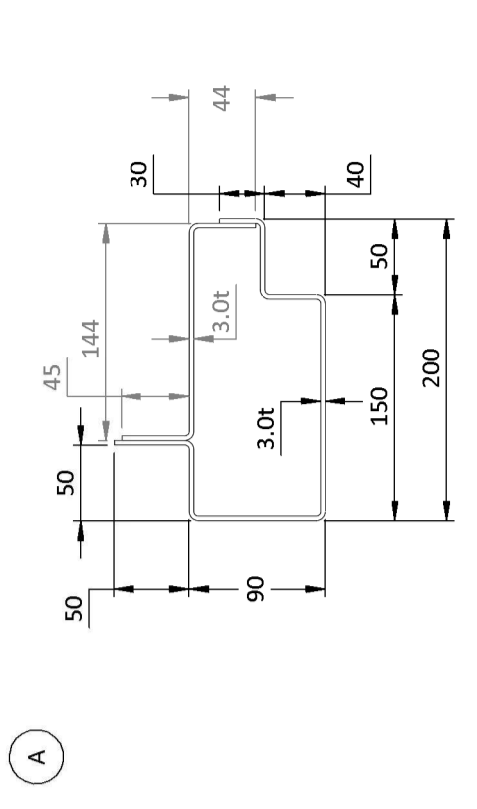

ISSUE	DATE	APPD	DOCN
1			
2			
3			
4			
5			
6			
7			
8			
9			

	PROJECTION THIRD ANGLE
	GENERAL DIMENSIONAL TOLERANCES EXCEPT WHERE STATED
	SURFACE TEXTURE UM C.L.A. UNLESS OTHERWISE STATED
	DO NOT SCALE IF IN DOUBT ASK!
	ALL DIMENSIONS IN MILLIMETRES UNLESS OTHERWISE STATED

G&MACOUSTICSOLUTIONS  
259 Greenstead Road  
Colchester, Essex, CO1 2SJ  
Tel: +44(0)1206 790 754  
Fax: +44(0)1206 794 863  
www.gmpb.co.uk

PROJECT No. AS14/096  
DESIGN Ref. 14096

DRAWN BY KM  
DATE 07/11/14  
SCALE 1:50  
CHECKED  
SHEET 1 of 1  
SIZE A2  
DRAWING No. 14096-02-01